

Date

10/26/2023

DIALux

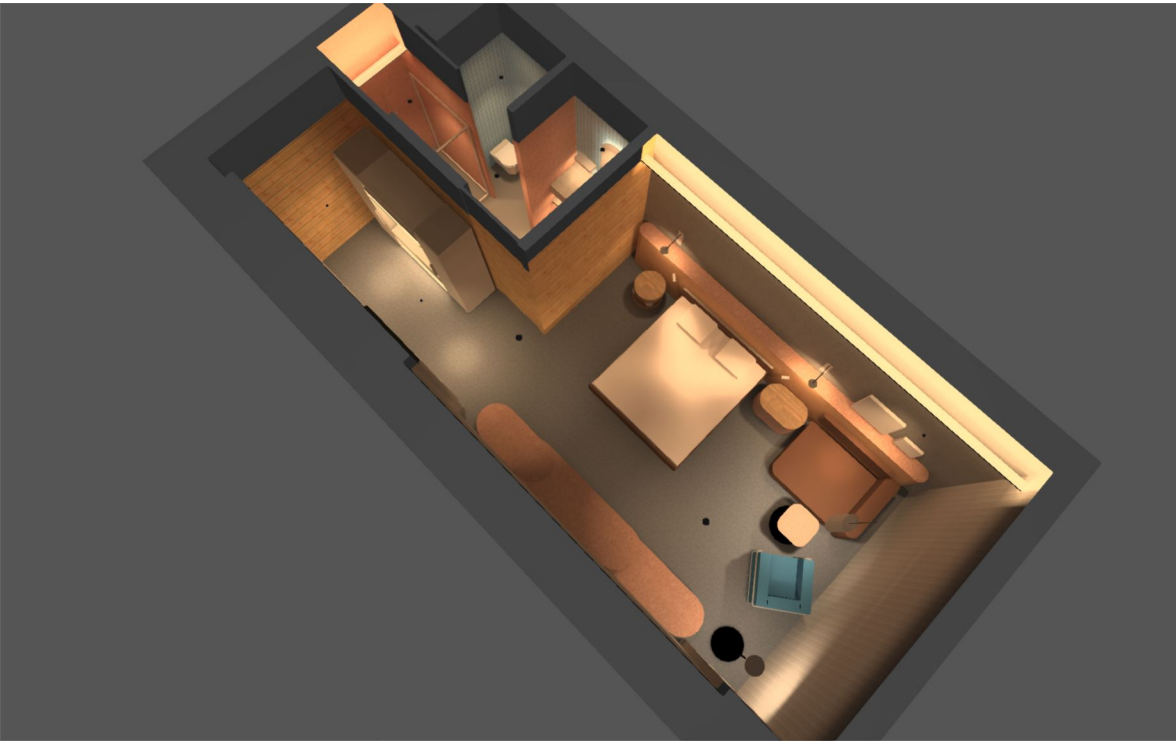

Project

Images

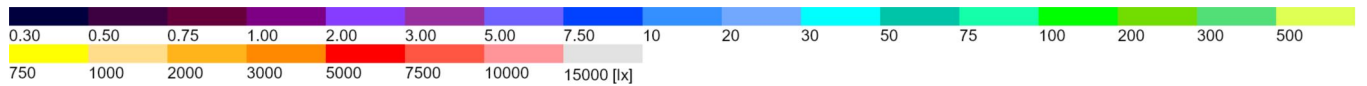
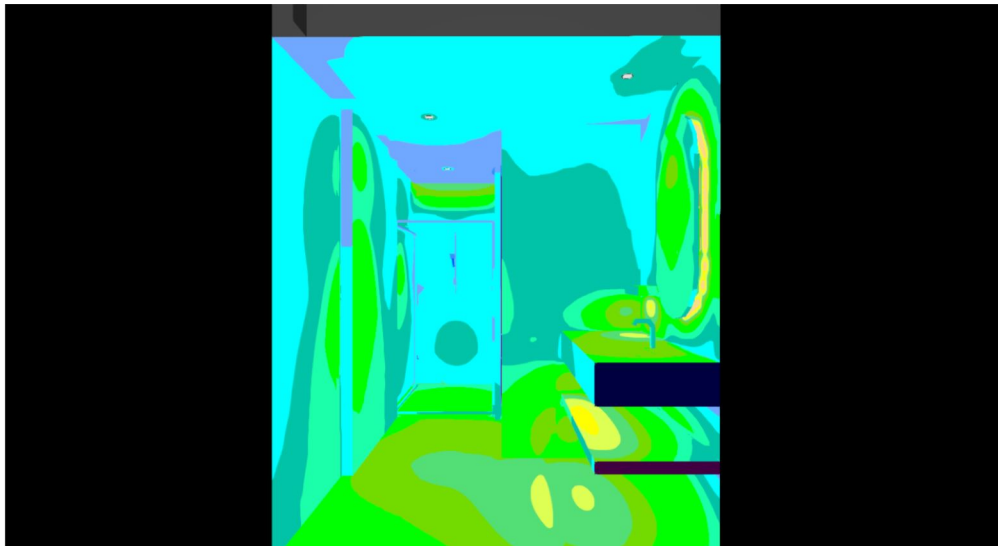

Images

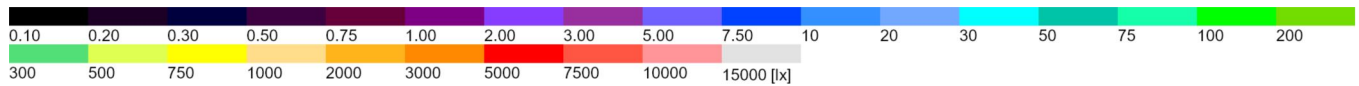
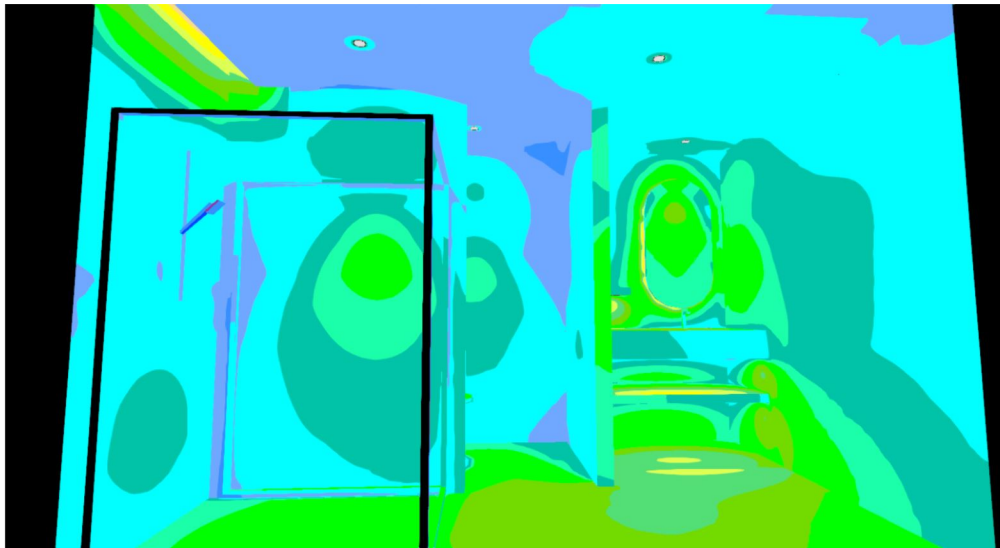

Images

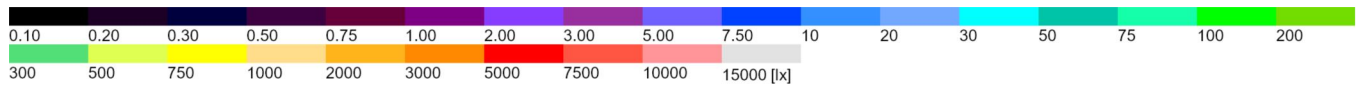
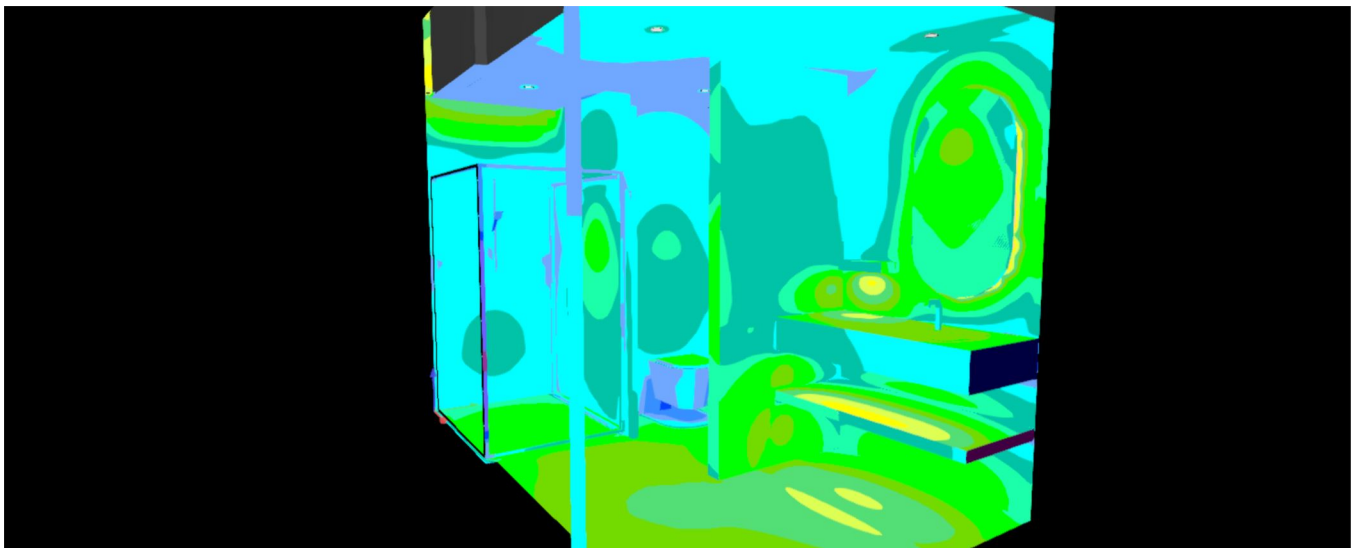

Images

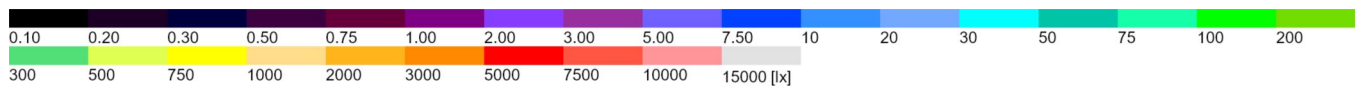
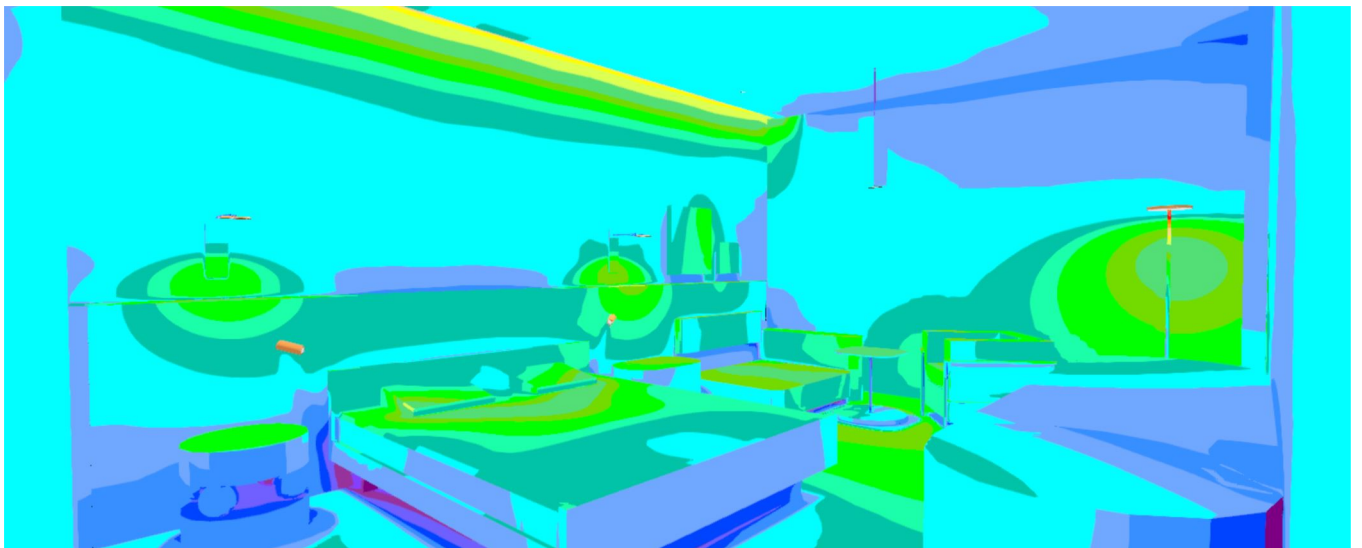

Images

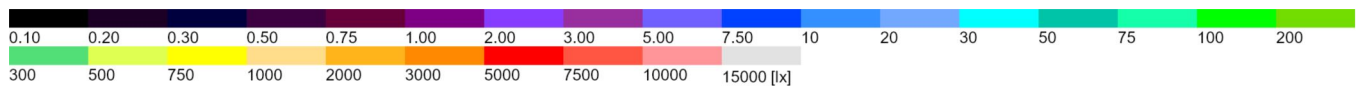
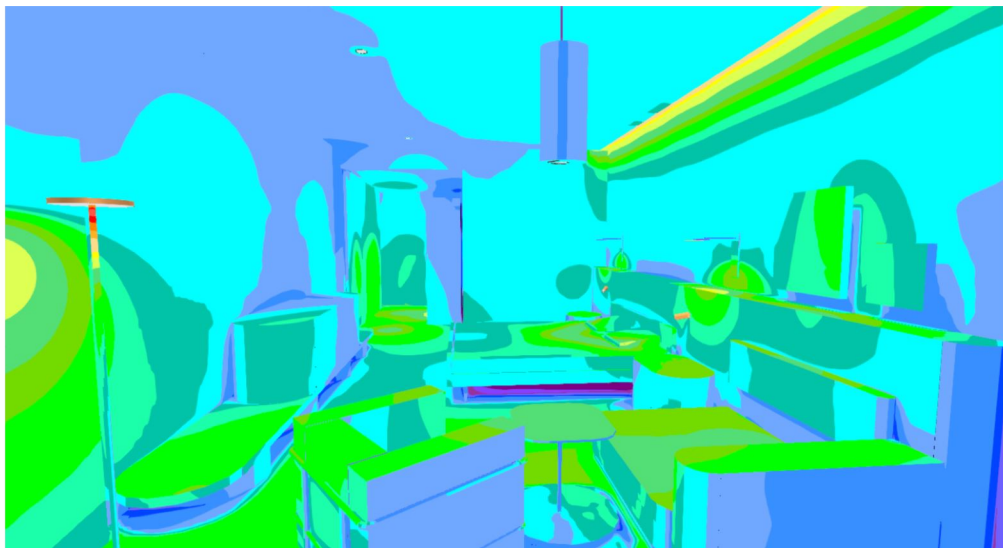

Images

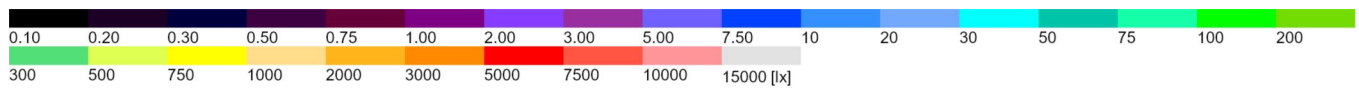
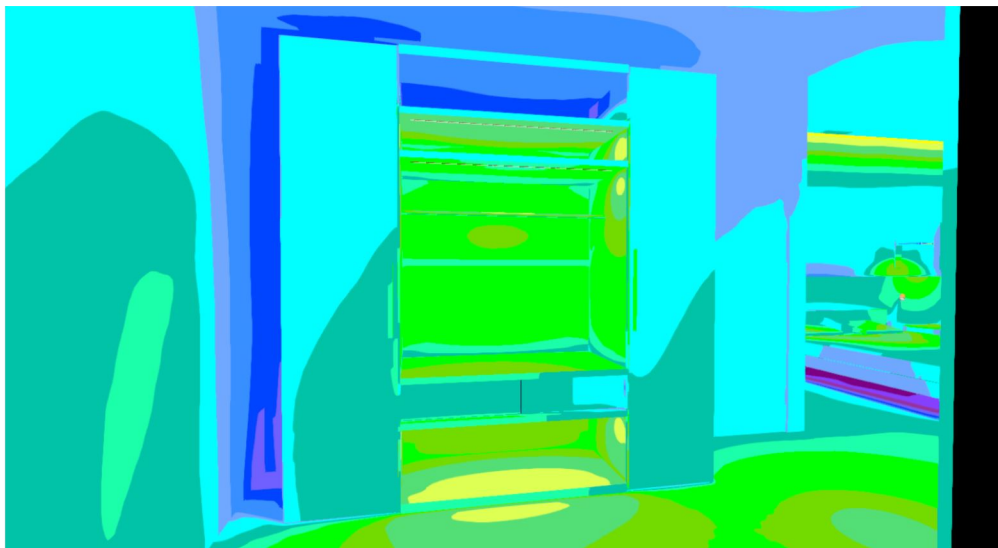
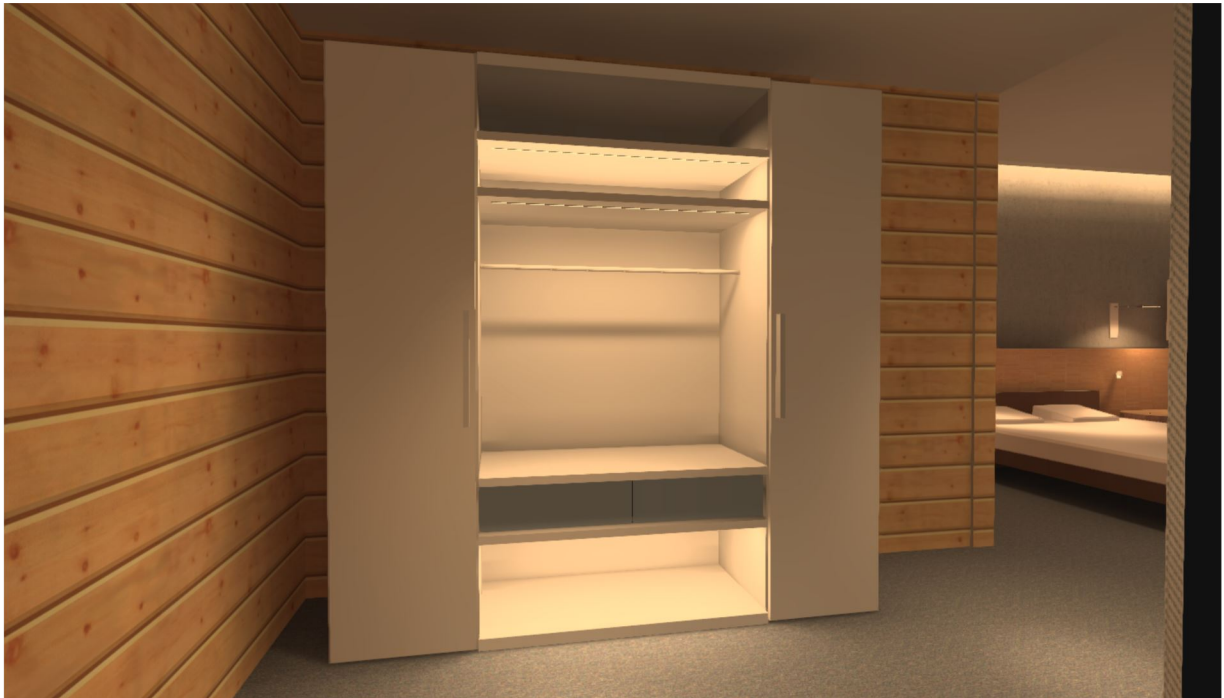

Images

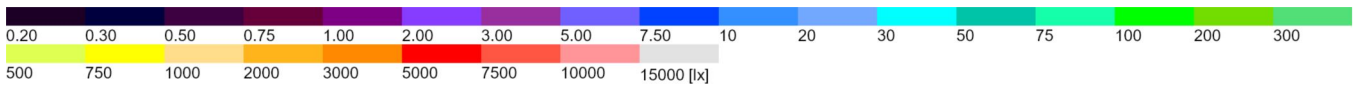
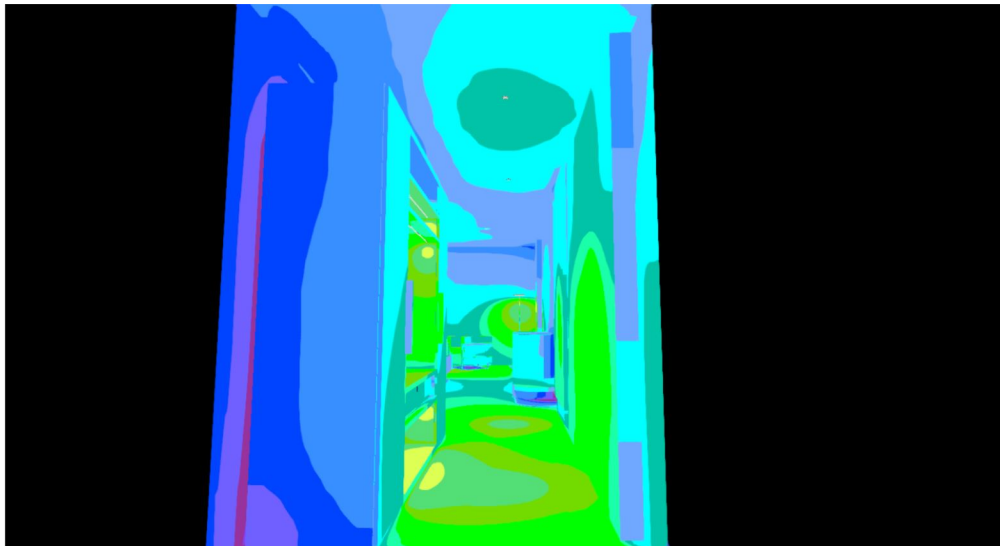

Images

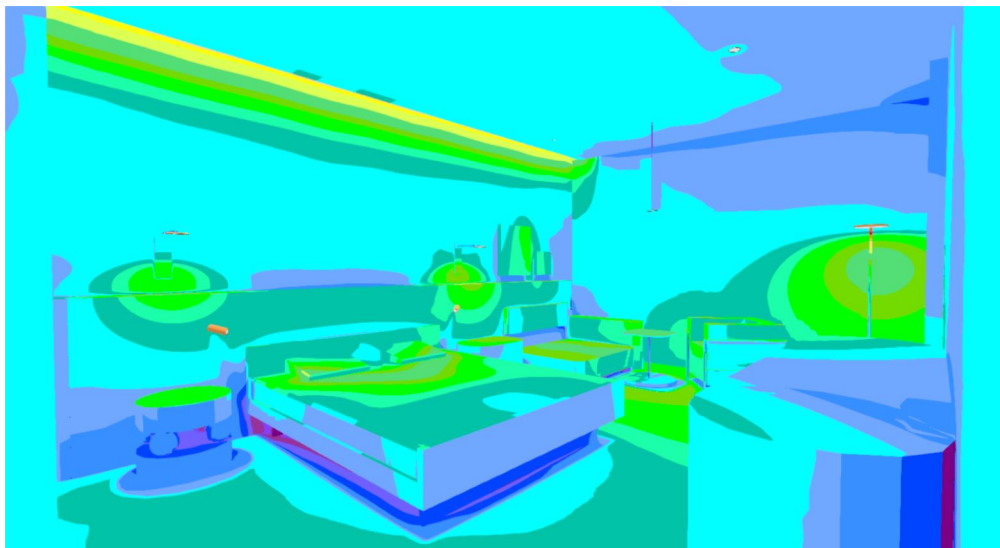

Images

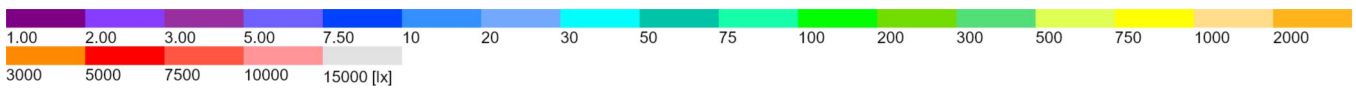
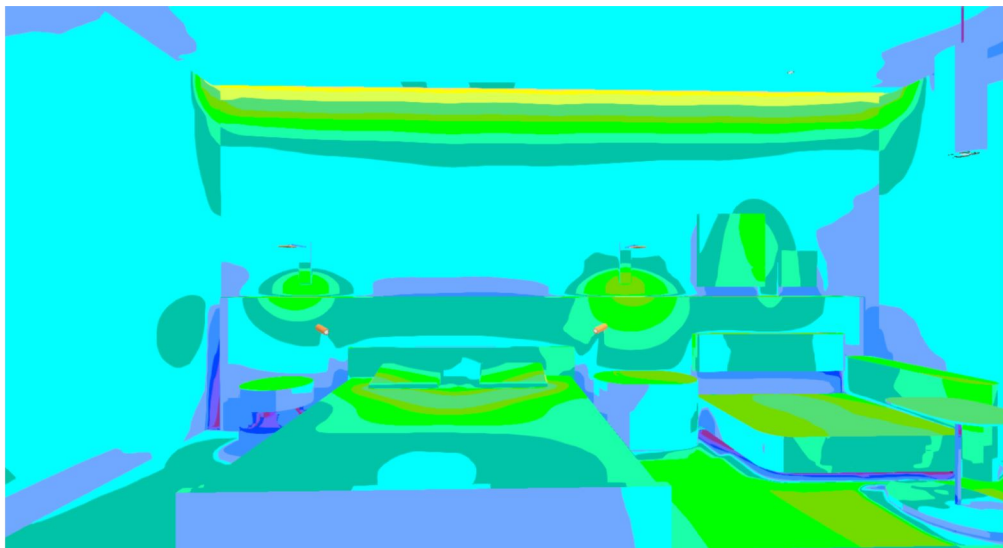

Images

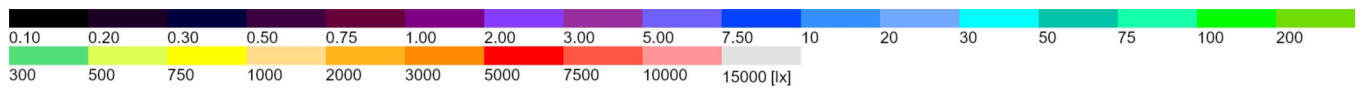
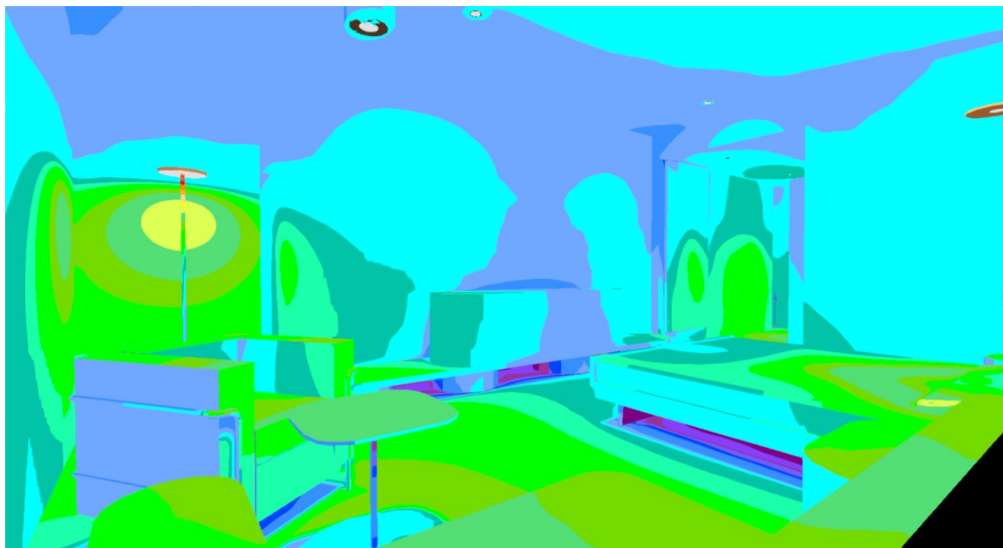

Building 1 · Storey 1 · BATHROOM (Light scene 1)

Calculation objects

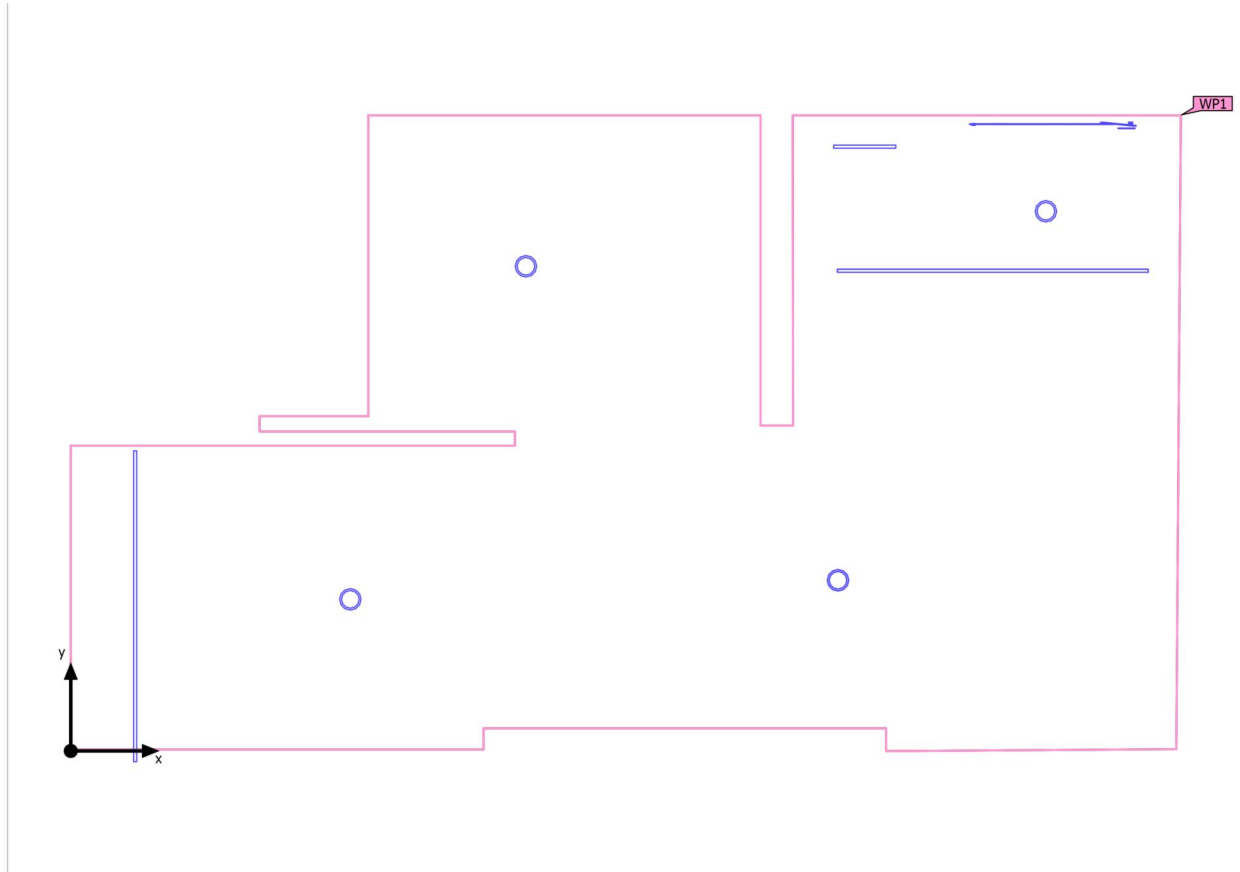

Building 1 · Storey 1 · BATHROOM (Light scene 1)

Calculation objects

Working planes

Properties	\bar{E} (Target)	E_{min}	E_{max}	$U_o (g_1)$ (Target)	g_2	Index
Working plane (BATHROOM) Perpendicular illuminance (adaptive) Height: 0.800 m, Wall zone: 0.000 m	186 lx (≥ 500 lx) ✗	0.13 lx	585 lx	0.001 (≥ 0.60) ✗	0.000	WP1

(1) Based on a rectangular space of 3.571 m x 2.045 m and SHR of 0.25.

Utilisation profile: DIALux presetting (34.2 Standard (office))

Building 1 · Storey 1 · BATHROOM (Light scene 1)

Working plane (BATHROOM)

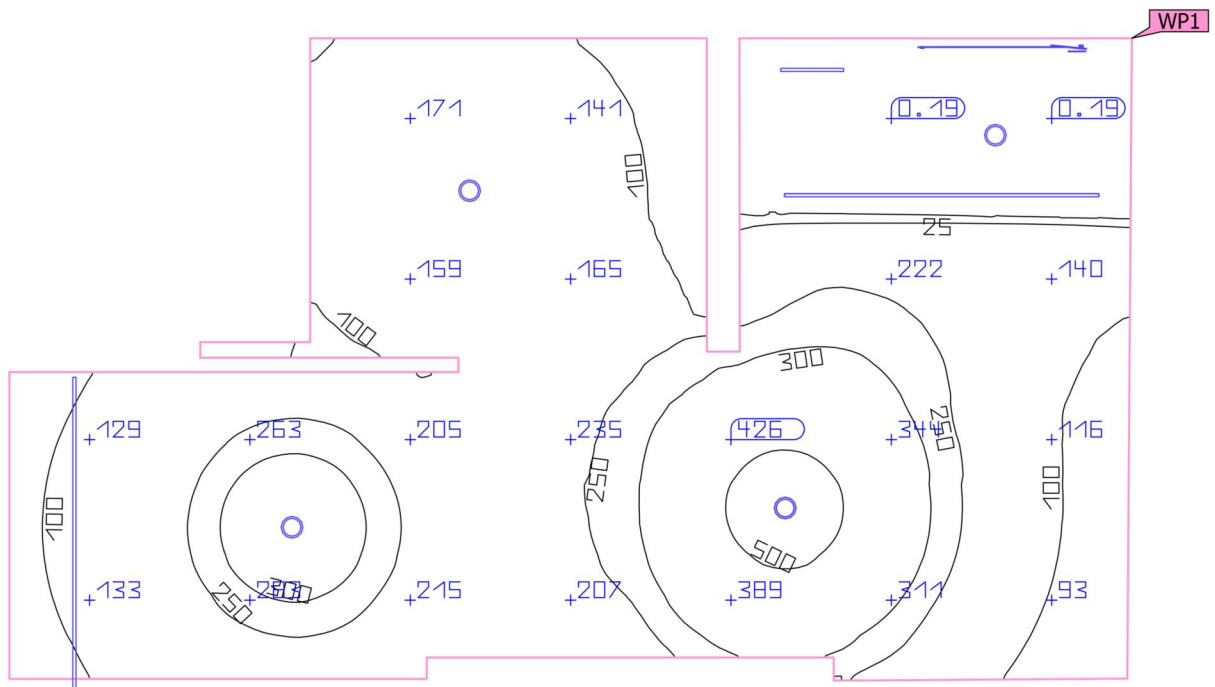
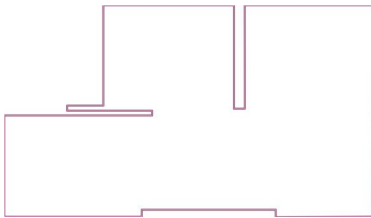

Properties	\bar{E} (Target)	E_{min}	E_{max}	$U_o (g_1)$ (Target)	g_2	Index
Working plane (BATHROOM) Perpendicular illuminance (adaptive) Height: 0.800 m, Wall zone: 0.000 m	186 lx (≥ 500 lx)	0.13 lx	585 lx	0.001 (≥ 0.60)	0.000	WP1
	✗			✗		

Utilisation profile: DIALux presetting (34.2 Standard (office))

Building 1 · Storey 1 · KING BEDROOM (Light scene 1)

Calculation objects

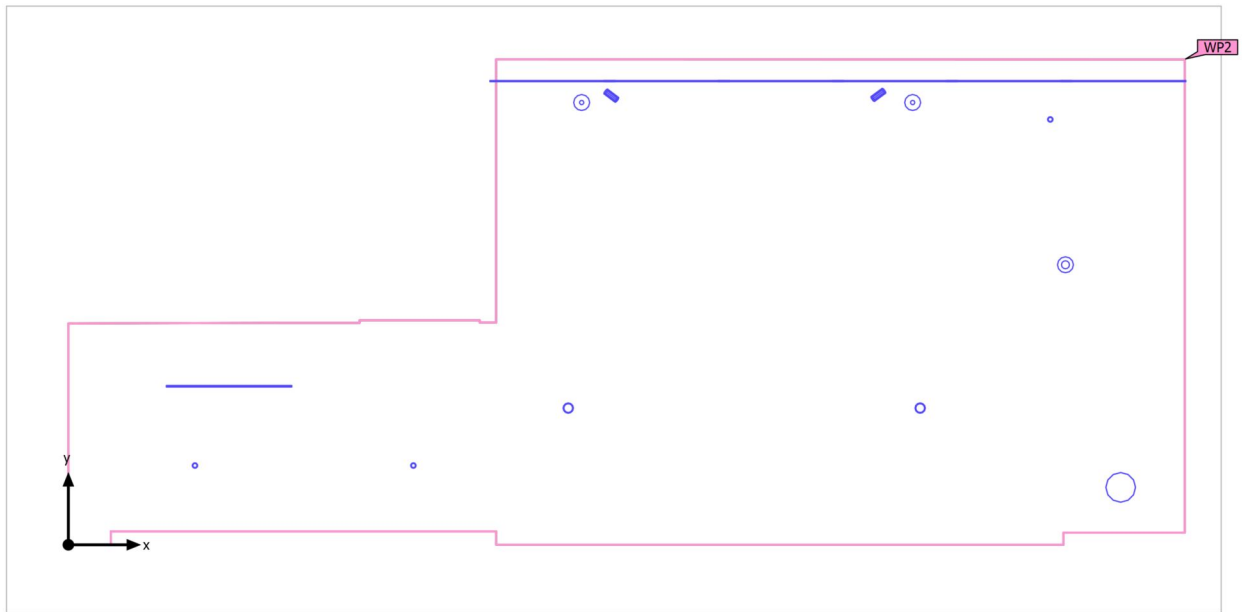

Building 1 · Storey 1 · KING BEDROOM (Light scene 1)

Calculation objects

Working planes

Properties	\bar{E} (Target)	E_{min}	E_{max}	$U_o (g_1)$ (Target)	g_2	Index
Working plane (KING BEDROOM) Perpendicular illuminance (adaptive) Height: 0.800 m, Wall zone: 0.000 m	142 lx (≥ 500 lx) ✗	1.15 lx	778 lx	0.008 (≥ 0.60) ✗	0.001	WP2

(1) Based on a rectangular space of 8.903 m x 3.872 m and SHR of 0.25.

Utilisation profile: DIALux presetting (34.2 Standard (office))

Building 1 · Storey 1 · KING BEDROOM (Light scene 1)

Working plane (KING BEDROOM)

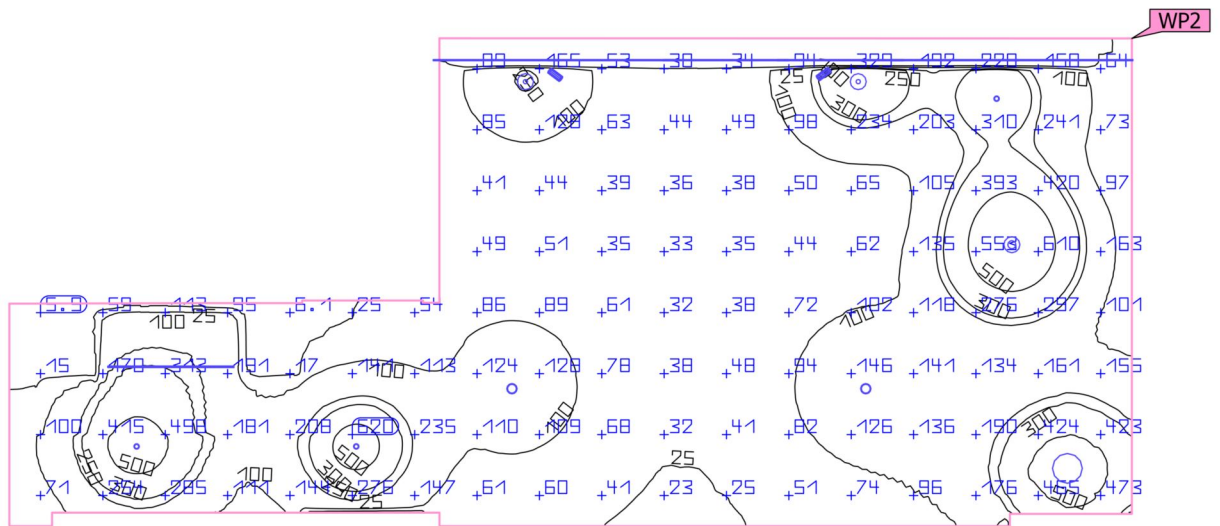
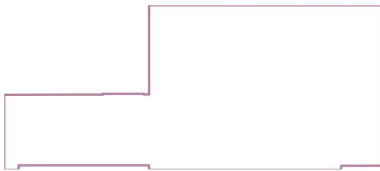

Properties	\bar{E} (Target)	E_{min}	E_{max}	U_0 (g ₁) (Target)	g ₂	Index
Working plane (KING BEDROOM) Perpendicular illuminance (adaptive) Height: 0.800 m, Wall zone: 0.000 m	142 lx (≥ 500 lx)	1.15 lx	778 lx	0.008 (≥ 0.60)	0.001	WP2
	✗			✗		

Utilisation profile: DIALux presetting (34.2 Standard (office))